

System Saver 1200 Plus Series Air Dryers

CONDITION	POSSIBLE CAUSE	SOLUTION
Dryer leaks from purge valve during compressor loaded cycle. The leak may cause excessive compressor cycling or prevent the system from building air pressure.	The governor may be malfunctioning.	Remove the air line from port 4 of the dryer. If purge valve stops leaking, find the source of the air that is pressurizing port 4. Possible source is the governor. Replace as needed.
	The turbo cut-off valve could be leaking.	Possible source can be the turbo cut-off valve. Replace as needed.
	The purge valve may be contaminated.	If the purge valve is still leaking, remove and inspect the purge valve. If ice is present, see air dryer frozen condition. If contamination is found, clean and reinstall.
	The purge valve seal may be damaged or out of position.	If purge valve seal is compromised, repair/replace purge valve.
Air dryer purges too often, perhaps as frequently as every 15 seconds, accompanied by excessive cycling of the compressor.	Leak in the line between compressor and dryer port 4.	Check the air compressor to dryer port 4 line for leaks. Repair or replace line.
	Leaking at the air compressor unloader(s).	Check compressor unloader(s) for leaks. Repair or replace for large leaks (1-inch diameter bubbles in 3 seconds).
	Excessive air system leakage or usage.	If primary and secondary air tanks are losing pressure, find the leaks and repair air system leaks. If primary and secondary air tanks are <u>not</u> losing pressure,
	Outlet check valve not sealing.	Then the problem can be the outlet check valve leaking. Inspect the outlet check valve and repair or replace as required.
	Governor has less than 16 psi range or leaking at the gasket/O-rings.	Or the problem can be the governor. Replace leaking O-ring/gaskets.
Rapid "puffing" of air from purge valve in small amounts. Frequency varies with engine speed.	Normal for non-turbo cut-off valve air dryers.	If the dryer is not equipped with a turbo cut-off valve, the system is operating correctly.
Air leak at turbo cut-off valve vent.	Turbo cut-off valve damaged or malfunctioning.	Remove turbo cut-off valve. If you see heat damage, correct the over temperature condition (see Application Guide TP-9672). Clean dryer bore and check for damage. Replace turbo cut-off valve if damaged components found. O-rings should be lubricated (see Maintenance Manual 34).
Air dryer frozen (water collecting in base of dryer is freezing).	No electrical power to heater.	Verify power and ground to heater with ignition on repair circuit as needed.
	Heater is malfunctioning.	Test heater resistance as specified in Maintenance Manual 34. Replace heater as needed.
No air pressure build-up in system.	Air system leaks, such as compressor discharge line, air dryer, reservoirs, brake and suspension valves.	Listen and check for large air leaks on air brake/suspension components. Repair or replace as needed. If compressor or dryer pressure relief valves are open, diagnose the cause. Remove the unloader line from the compressor and port 4 of the dryer. If the air system starts to build air pressure, find and repair the source of the unloader line pressure.
	Air governor malfunctioning.	One possible source may be a malfunctioning governor. Replace as needed.
	Turbo cut-off valve leaking.	Another possible source is the turbo cut-off valve. Inspect and replace as needed.
	Air compressor malfunctioning.	After completing steps 1 to 3, test compressor output according to manufacturer's guidelines. Replace as needed.
Oil or sludge in air system tanks.	Desiccant contaminated with oil.	Inspect compressor for oil passage per manufacturer's instructions. Replace cartridge with coalescing cartridge.
Water in system tanks, everything else checks out okay.	Dryer inlet air temperature is too high.	Verify all OE bulletins are performed i.e. compressor discharge line kit.
	Incorrect replacement cartridge used.	Replace cartridge with Meritor WABCO replacement cartridge.
	Desiccant not getting correct regeneration.	Verify minimum 10 seconds of air flow out of the purge valve after the purge.
Dryer and/or compressor pressure relief valve leaking.	Pressure relief valve malfunction or air system restriction.	If the primary and the secondary tanks do not build pressure and the governor and unloader line are not malfunctioning, check for system restrictions and test the pressure relief valve.
	Governor malfunctioning or unloader line leak.	If the primary and secondary tanks reach 145 psi without a purge, verify the governor is pressurizing the unloader line and there are no leaks. If the compressor will not unload with the unloader applied, consult compressor manufacturer.

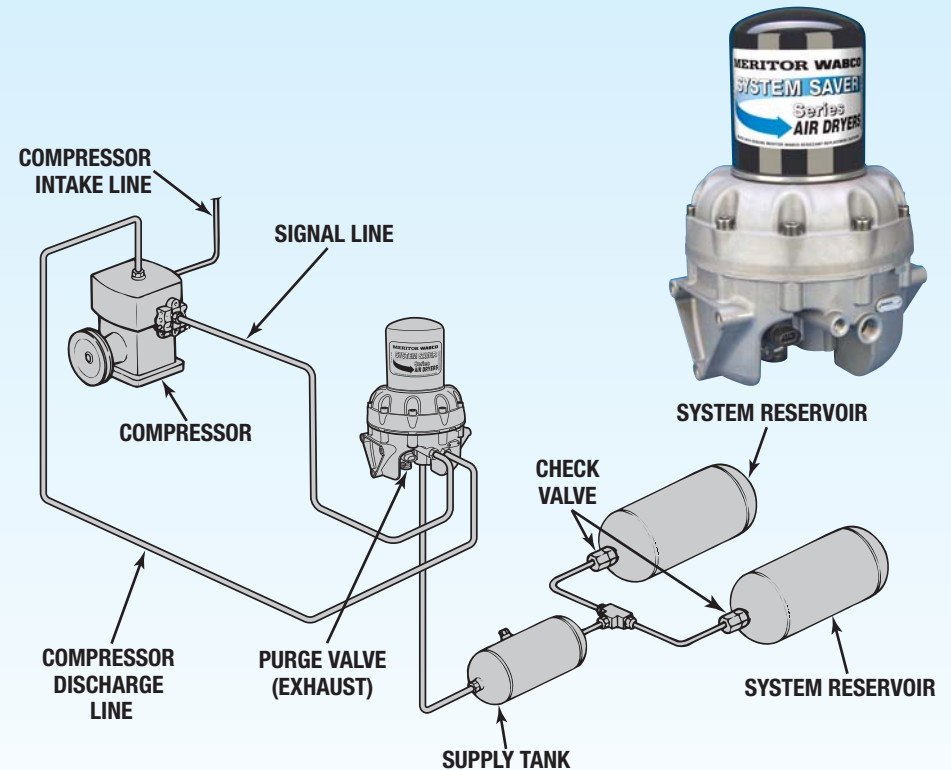

MERITOR WABCO
Safety Strong. Efficiency Smart.

For more information, see Maintenance Manual 34 or dial our toll-free number: 866-OnTrac1 (668-7221).

DESICCANT CARTRIDGE



R950011

COALESCING CARTRIDGE



R950068

PRESSURE RELIEF VALVE

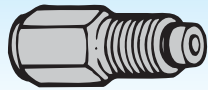

S2206-D-1226

GOVERNOR

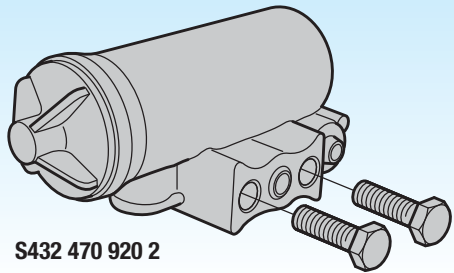

S432 470 920 2

HEATER

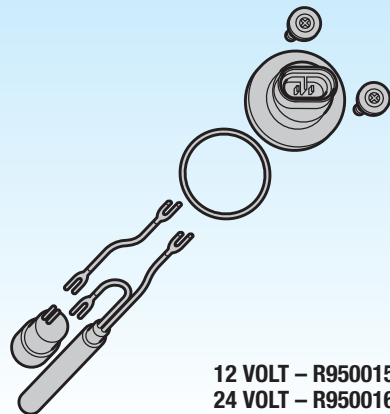

12 VOLT – R950015
24 VOLT – R950016

PURGE VALVE

Washer oriented with flange pointed down as shown.

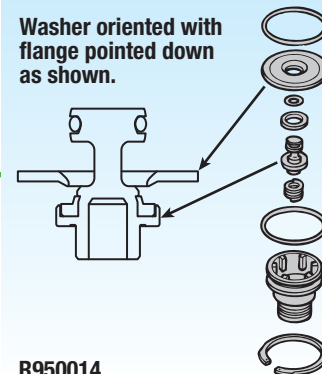

R950014

DATE CODE INFORMATION

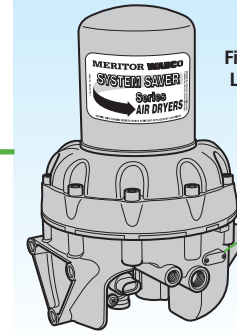

Date Code
First 2 Digits = Build Week
Last 2 Digits = Build Year

Manufacturing Location Code



I.D. Tag No.
Note: A Part Number with an "S" In Front of it Indicates a Rockwell WABCO Service Part Number.

OUTLET CHECK VALVE

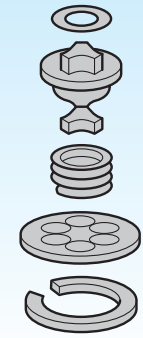

S432 470 922 2

TURBO CUT-OFF VALVE



S432 470 921 2

